

Schueco solutions for education projects



Experience matters



Manchester School of Art
Architect: Feilden Clegg Bradley Studios

When it comes to specifying for projects in the education sector, experience matters. Having worked extensively on schools and universities in the UK and Ireland for over thirty years, Schueco UK has that experience.

Our portfolio of educational projects is varied and impressive and we have gained the respect of architects and specifiers for the quality and breadth of our systems.

Backed by a nationwide network of highly trained network partner companies whose role is to design and install our systems to the highest standards, Schueco UK can help make a project happen in a timely manner and at a cost that represents best value.

Front cover: Corby Business Academy
Architect: Foster + Partners



Canterbury Christ Church University
Architect: ADP



Bath Spa University
Architect: cube_design

A tailored service

Schueco UK prides itself on offering a bespoke technical service tailored to a project's specific requirements.

The Technical Services team in Milton Keynes has over thirty years' experience of designing solutions for the education sector and is used to working in close collaboration with architects, main contractors, fabricators and clients.

And for everyone connected with the planning or execution of an education project in the London area or elsewhere, the offices and showroom of Schueco

London in Great Portland Street, W1 is also an invaluable resource. Equipped with permanent displays of Schueco façades, windows, sliding doors and entrance doors, the facility has experienced staff available to offer technical advice on all systems and their applications.

In addition, Schueco UK's network partners are fully aware of the special demands of educational projects; they understand the need to be able to accommodate academic routines and the crucial importance of health and



LAMDA, London
Architect: Niall McLaughlin Architects

© Nick Kane

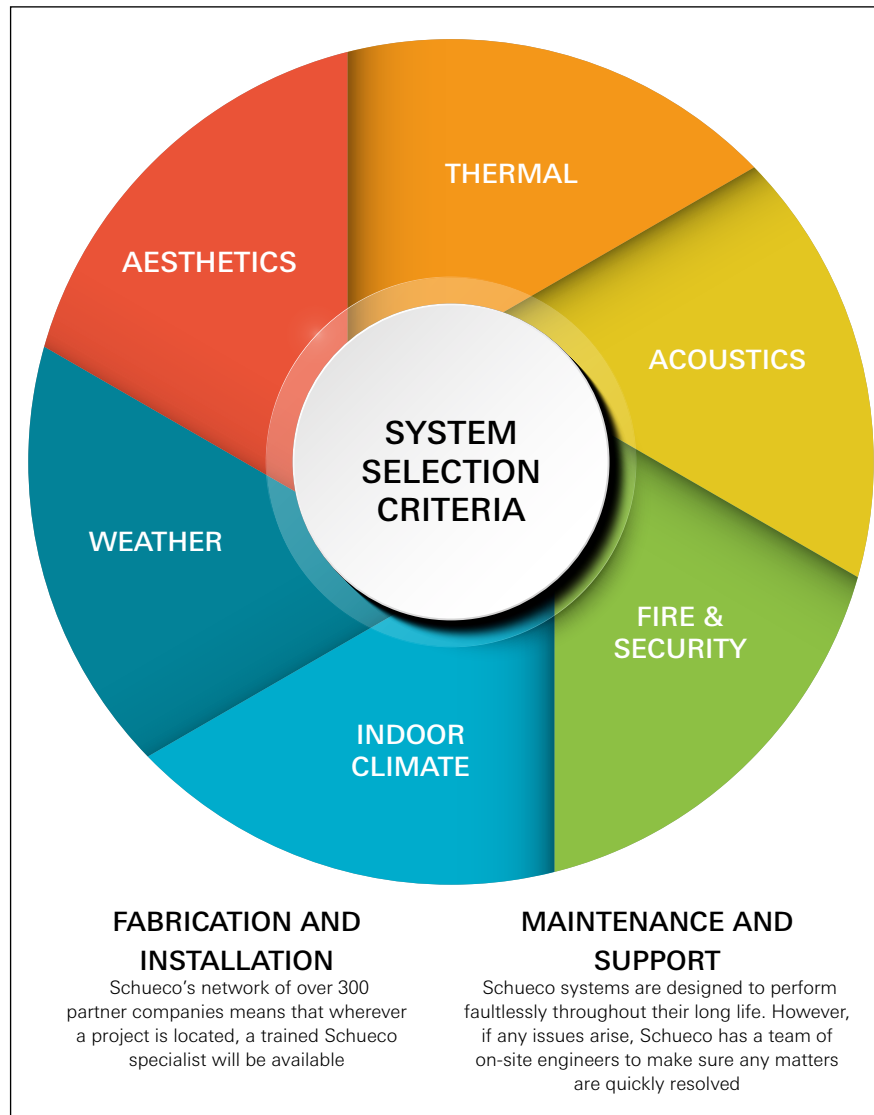

safety measures when working around young people.

The systems they install will be those that best fulfil the criteria for each project, namely excellent thermal and acoustic insulation to provide a calm atmosphere in which to learn and overall sustainability in terms of energy usage and recyclability to safeguard the environment.

Schueco UK is therefore well-equipped to assist a project at all key stages from initial design right through to fabrication, installation and maintenance.

A perfect solution for any requirement

Schueco offers solutions that have been specially designed to withstand the particular rigours of educational establishments. Our Ground Floor Treatment (GFT) system, developed for high-traffic areas, is a perfect example of this approach.

A combination of façade, window and door systems, the GFT system includes a Schueco ADS 65 pivot door equipped with cleats and tie-rods top and bottom to maximise durability and minimise expensive replacement and/or maintenance costs.

Similarly, the narrow sightlines of the façade minimise the use of raw materials and allow light to flood the building, simultaneously benefiting the environment and improving the students' learning experience.

- High-performance thermally broken GFT system with a basic depth of 65 mm
- Narrow 50 mm sightlines
- Single- and double-leaf pivot door options
- Anti-finger trap and standard jamb profile options

- Fully compliant with The Equality Act 2010
- Compatible with Schueco AWS 70 SC windows and FWS façade systems
- Maximum leaf dimensions of 1.1 x 2.5 m
- Maximum leaf weight of 100 kg
- Certified burglar resistance to PAS 24

GFT screen, ADS 65 pivot door and AWS 70 SC window example combinations

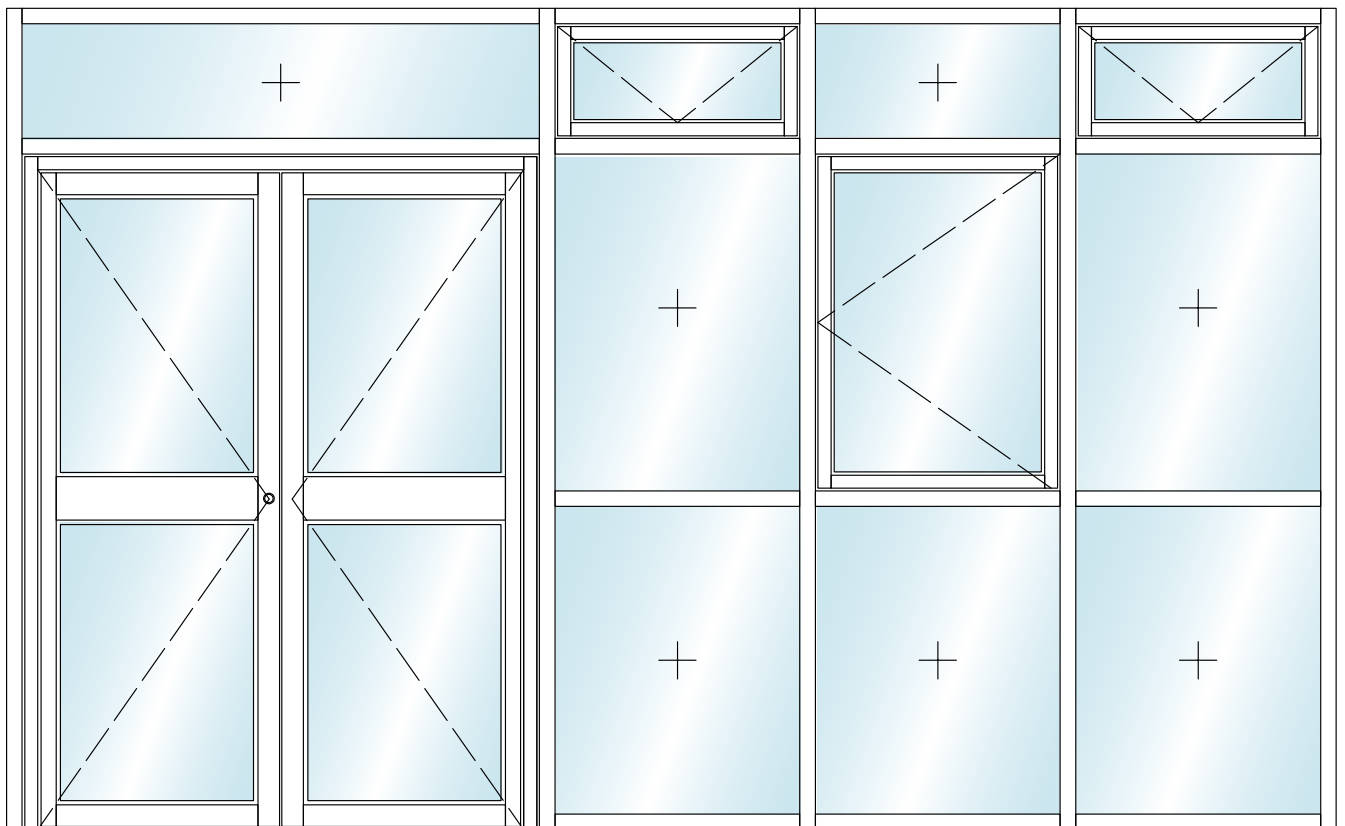

Seamless integration

The Schueco GFT system and the complementary Schueco façade and window systems integrate seamlessly to create a complete building envelope solution for all education sector projects.

The combination of a Schueco FWS 35, 50 or 60 mm façade, AWS windows and ADS pivot door delivers outstanding insulation values with a high level of aesthetic appeal.

The slender sightlines that are a common feature of all the individual elements in the system belie their unrivalled strength and durability, making the Schueco GFT system perfect for schools and colleges.

- Multiple façade design options with sightlines from 35 to 60 mm
- Schueco FWS façade thermal performance to Passive House standards with U_f as low as $0.67 \text{ W}/(\text{m}^2\text{K})$

- Award-winning sustainability with Cradle-to-Cradle certification for Schueco FWS 50.SI
- Schueco AWS 70 SC window system maximises daylight with sightlines as narrow as 38 mm for fixed lights and 63.5 mm for opening units

AWS 70 SC windows inserted into GFT façade

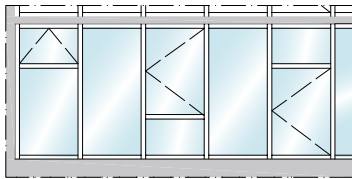

GFT single door and AWS 70 SC windows into GFT façade

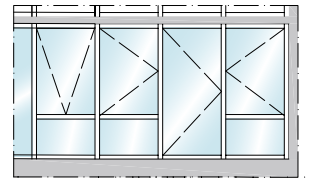

Ribbon window AWS 70 SC

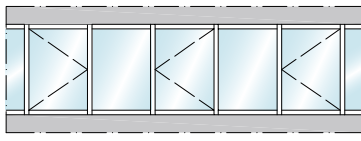

Punched opening AWS 70 SC

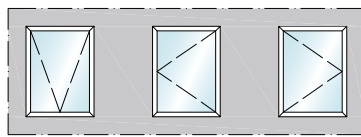

GFT double doors into FWS façade

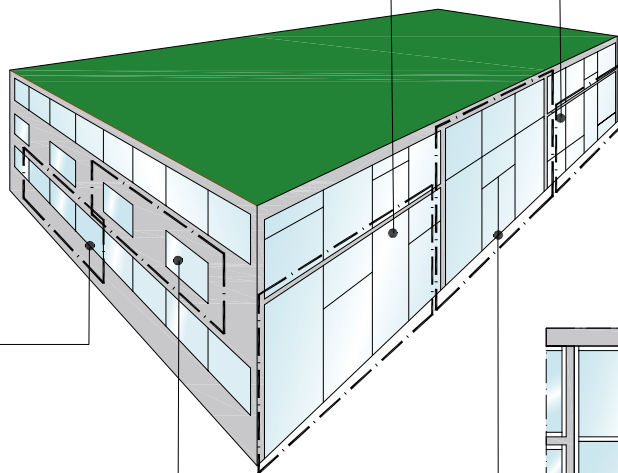
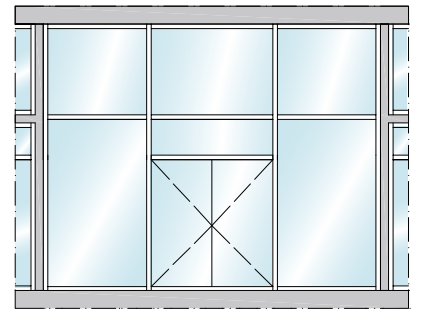

Indicative GFT uses such as ground floor treatment areas, façade scenarios and combinations with other systems

CAD and BIM

Schueco UK has been in the forefront of the digital revolution for many years, recognising that improved efficiency and reduced waste will lead to dramatic improvements in productivity that will benefit clients and the environment.

Schueco has fully embraced computer-aided design and offers a complete suite of CAD details for all systems, allowing designers to take full advantage of the technology. These can be downloaded from the Schueco website: www.schueco.co.uk

Schueco UK was also the first company in the country to assemble a library of BIM-enabled aluminium fenestration families and its SchüCal+ software enables its network partners to deal easily with BIM-compliant projects.

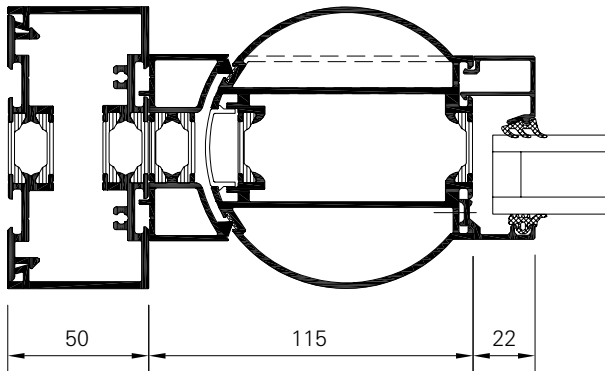

Pivot door with anti-finger trap stile option

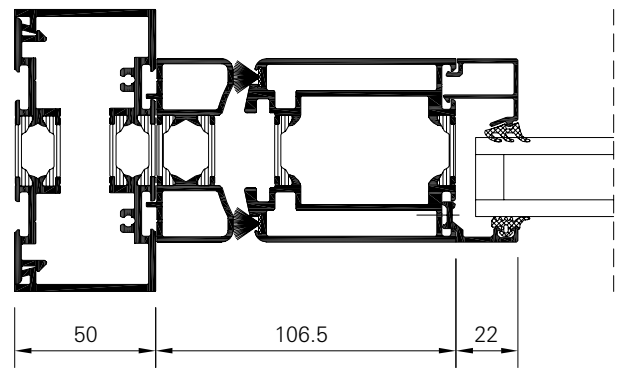

Pivot door with standard stile option

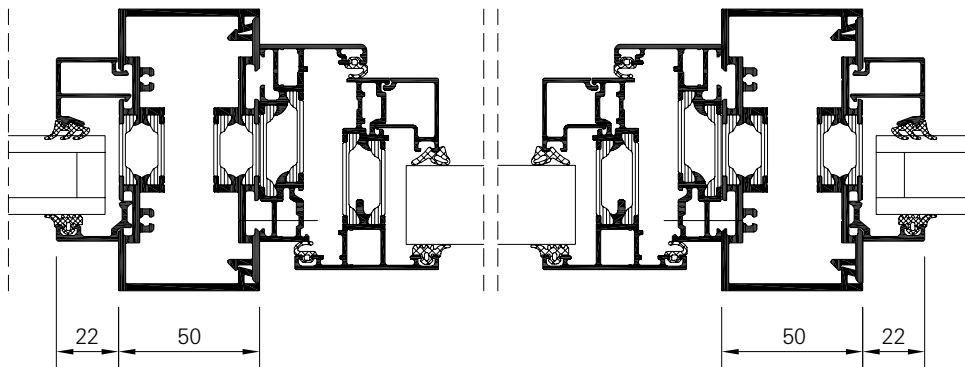

Integration of AWS 70 SC window into GFT 50 screen

Schueco London: a facility that offers more

To complement Schueco UK's existing showroom at their headquarters in Milton Keynes, the Schueco London office and showroom is a new 3,695 sq ft facility which has been specially designed to offer visitors additional access to Schueco UK's systems and technical services in a convenient central London location.

The premises include a spacious showroom containing Information Points and permanent displays of Schueco façade, window, sliding door and entrance door systems, giving architects and specifiers the opportunity to judge their quality for themselves.

And to augment this, a Virtual Reality facility shows further examples of systems in a variety of realistic settings.

Experienced Schueco staff are on hand to answer questions and to give technical advice on the capabilities of individual systems. Appointments to discuss the requirements of particular projects are welcomed.

The London office and showroom also hosts regular CPD seminars and training events. To arrange a visit or to use the comfortable conference facilities, call 020 7704 6704 or email london@schueco.com

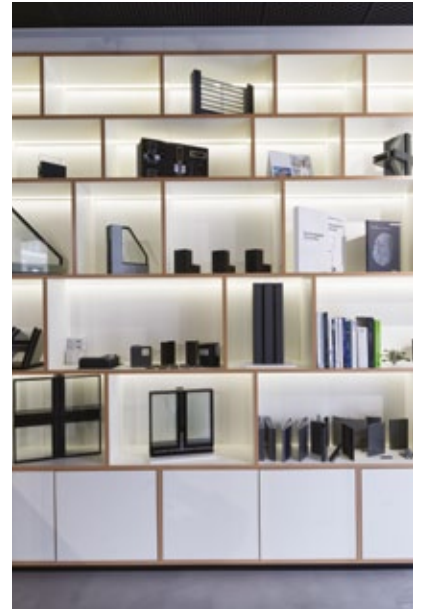

The showroom, design support office and event space of Schueco London

Schueco solutions for education projects



Schueco UK's knowledge of the education sector means that the systems it recommends are based on experience of what works in practice. The company recognises the financial constraints under which the sector operates and understands the need for every education project to deliver best value.

In addition, Schueco knows that the education environment can be a challenging one with doors, in particular, being subjected to heavy

traffic and much rough treatment.

Accordingly, every Schueco system has been tried and tested and is built to last, enabling the company to put forward solutions that will be cost-effective and sustainable over the long term.

Schueco UK Ltd

www.schueco.co.uk

Schueco – System solutions for windows, doors and façades.

Based in Bielefeld, the Schüco Group develops and sells system solutions for windows, doors and façades. With 5,400 employees worldwide, the company strives to be the industry leader in terms of technology and service today and in the future. In addition to innovative products for residential and commercial buildings, the building envelope specialist offers consultation and digital solutions for all phases of a building project – from the initial idea through to design, fabrication and installation. 12,000 fabricators, developers, architects and investors around the world work together with Schueco. The company is active in more than 80 countries and achieved a turnover of 1.670 billion euros in 2018.

Schueco UK Ltd is a wholly-owned subsidiary of the Schüco Group. Established over 30 years ago, it is the leading specialist in building envelope solutions in the UK and Ireland with a coveted network of partner companies.

For more information, visit www.schueco.co.uk

SCHÜCO