



**ASTON**  
ARCHITECTURAL  
ALUMINIUM



**AW-47**  
**CASEMENT WINDOW**

**AD-55**  
**ARTISAN DOOR**



Delivering outstanding quality, with class leading performance and security

**FEATURES**







- » Alternative to steel doors
- » Attractive, slim-line profiles offer reduced sightlines
- » Fabricated using mitred corners
- » Stock colours - 7016M Grey & 9005M Black

**APPLICATION**

Residential «  
Retail/commercial «

**Technical Performance**

<b>U Value</b>	1.5 W/m <sup>2</sup> K (using sealed unit 1.0 W/m <sup>2</sup> K)
<b>Air</b>	Class 4, 600Pa
<b>Water</b>	Class 9A, 600Pa
<b>Wind</b>	Class AE, 2400Pa
<b>PAS 24:2016</b>	Enhanced security performance

 <b>U Value</b> 1.5W/m <sup>2</sup> k	 <b>Wind</b> 2400Pa	 <b>Water</b> 600Pa
 <b>Certified</b> PAS 24:2016	 <b>Air</b> 600Pa	 <b>WER</b>

## RECOMMENDED DESIGN LIMITS

Side Hung Vent Max Width	700mm
Side Hung Vent Min Width	400mm
Side Hung Vent Max Height	1400mm
Top Hung Vent Max Width	1400mm
Top Hung Vent Max Height	1400mm
Top Hung Vent Min Height	400mm
Max Vent Weight	40kg

## CONFIGURATIONS

- » Fixed externally glazed
- » Casement outward opening
- » Top hung and side hung

### AW-47 Casement Window

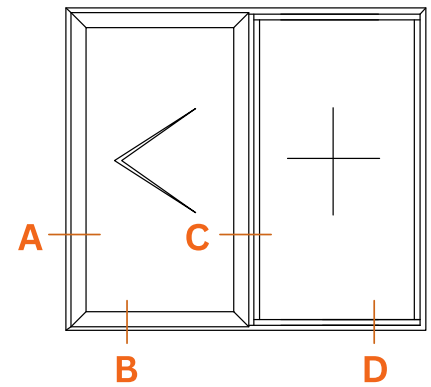

## CROSS SECTIONS

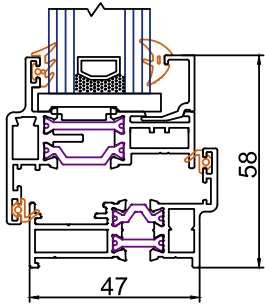

B

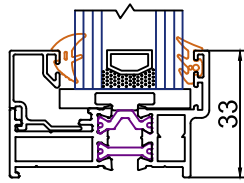

D

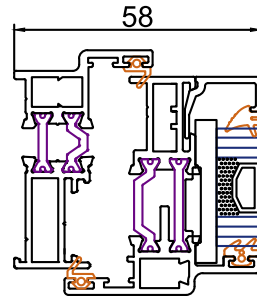

A

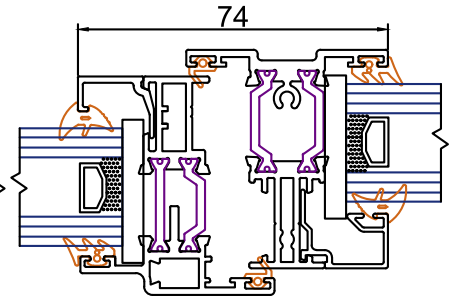

C

## RECOMMENDED DESIGN LIMITS

Max Sash Width	900mm
Max Sash Height	2100mm

## CONFIGURATIONS

- » Single or double doors
- » Inward opening or outward opening

### AD-55 Artisan Door

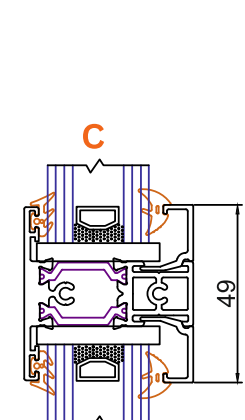
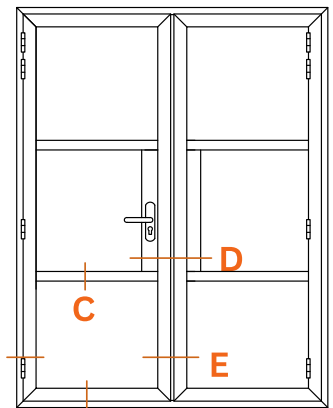

C

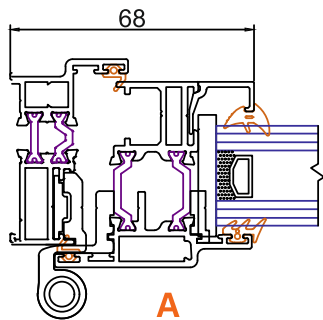

A

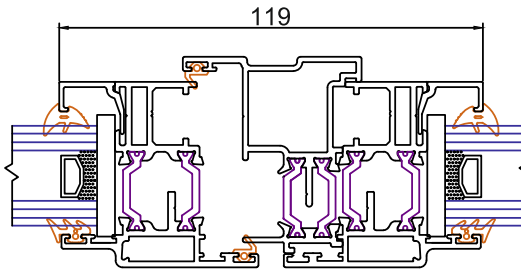

E

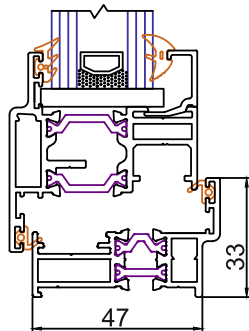

B

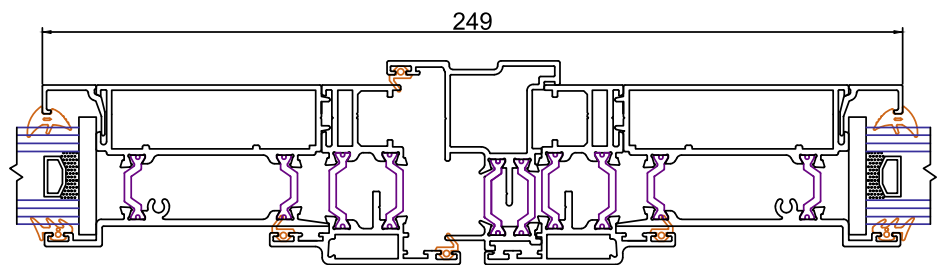

D

01923 510 220

info@astonaa.co.uk

01923 396 720

www.astonaa.co.uk

**Aston Architectural Aluminium Limited**  
Unit 8 Byfleet Industrial Estate  
Old's Approach, Watford,  
WD18 9TS